



-  **Oiless, Single Stage, Direct Drive, Electric Air Compressor**
-  **Sans l'huile, d'un seule étape, à prise directe, compresseur d'air électrique**
-  **Sin aceite, de una sola etapa, de mando directo, compresor de aire eléctrico**



Specification Chart _____ **Tableau des spécifications** _____ **Cuadro de especificaciones**

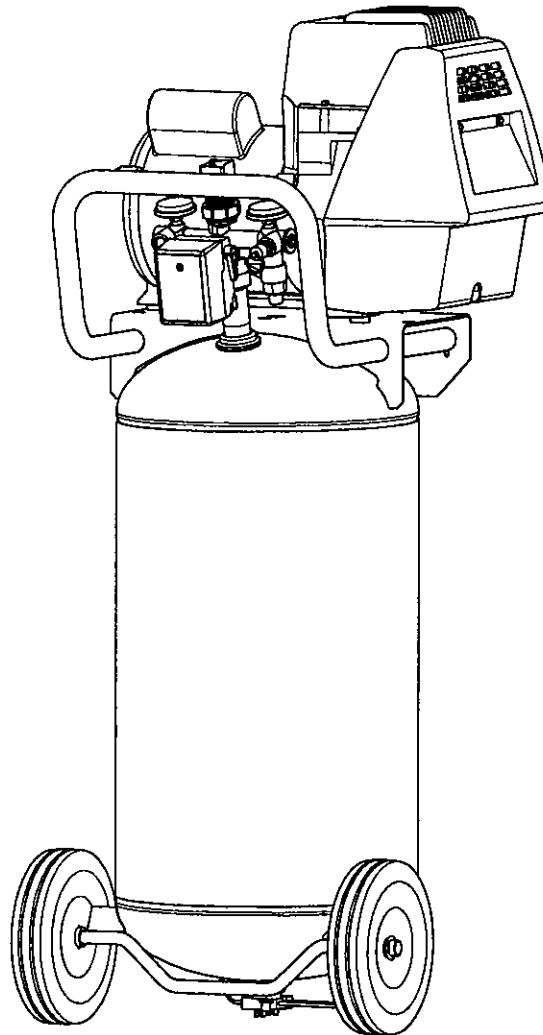

MODEL NO. (MODÈLE) (MODELO)	TANK CAPACITY GALLONS (CAPACITÉ DU RÉSERVOIR - LITRES) (CAPACIDAD DEL TANQUE - LITROS)	VOLTAGE/AMPS/ PHASE (TENSION/AMPS/ PHASE) (VOLTAJE/AMP/ FASE)	CFM (l/min) @ 40 PSI (2,8 bar)	CFM (l/min) @ 90 PSI (6,3 bar)	KICK-IN PRESSURE (PRESSION D'OUVERTURE) (PRESION DE CONEXION)	KICK-OUT PRESSURE (PRESSION DE FERM.) (PRESION DE DESCONEXION)
CLC631110	11 (41)	115/15/1	6.3 (179)	3.6 (102)	95 (6,6 bar)	125 (8,6 bar)

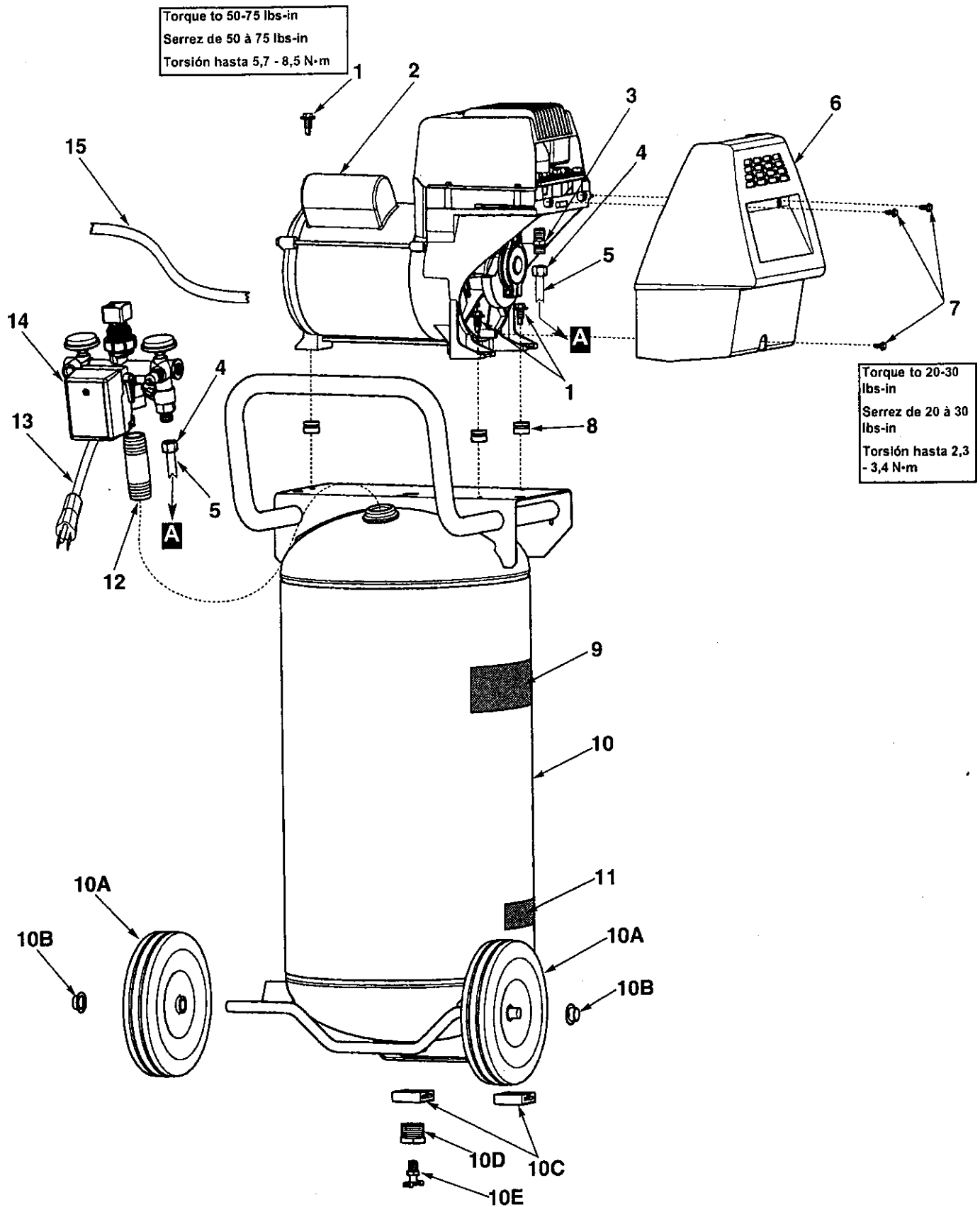

Questions? See back page. _____ Questions ? Consultez la page final. _____ ¿Preguntas? Vea la página final.



Note: Tighten compression nut #5 handtight plus 1 full turn.
Note: Serrez l'écrou #5 de compactage solide plus 1 plein tour.
Nota: Apriete la tuerca #5 de la compresión handtight más 1 vuelta completa.

Item Art <u>Art</u>	Part No N° / P <u>Núm / P</u>	Qty Qté <u>Cant</u>	 <u>Description</u>	 <u>Description</u>	 <u>Descripción</u>
1	059-0221	3	Bolt, shoulder, 1/4-28	Boulon	Perno
2	040-0274	1	Pump/motor assy	Ensemble pompe/moteur	Conjunto de bomba/motor
3	068-0017	1	Connector	Connecteur	Conector
			1/4 NPT x 3/8" O.D. tube		
4	058-0007	2	Nut, 3/8" O.D. tube	Écrou	Tuerca
5	145-0327	1	Transfer tube A-A	Tube	Tubo
6	142-0112	1	Shroud	Enveloppe	Guardera
7	N/A	3	Screw, #8-32 x 7/16" lg	Vis	Tornillo
8	093-0019	3	Grommet	Oeillet	Arandela de cabo
9	098-0984	1	Caution label	Étiquette d'attention	Escritura de la etiquetade la precaución
10	127-0047	1	Tank assembly	Ensemble du réservoir,	Conjunto de tanque,
			<i>includes 10A-10E</i>	<i>102 litres, inclut 10A-10E</i>	<i>102 litros, incluye 10A-10E</i>
10A	095-0016	2	Wheel, 7"	Roue	Rueda
10B	033-0001	2	Hubcap	Chapeau de moyeu	Tapacubo
10C	094-0030	2	Pad	Tampon	Almohadilla
10D	N/A	2	Bushing, 3/4 NPT x 1/4 NPT	Bague	Buje
10E	072-0001	1	Petcock	Robinet de décompression	Llave de desagüe
11	098-1085	1	Warning label	D'avertissement étiquette	Amonestadora escritura de la etu
12	N/A	1	Nipple, 3/4" NPT x 3-1/2"	Manchon fileté	Niple
13	026-0030	1	Power cord	Câble	Cordón
14	See pages 4 & 5	1	Manifold assembly	Ensemble du collecteur	Conjunto de múltiple
15	026-0233	1	Interconnect cord	Câble	Cordón

*N/A - These are standard parts available at your local hardware store.

*N/A - Ces pièces sont des pièces standard disponibles en quincaillerie.

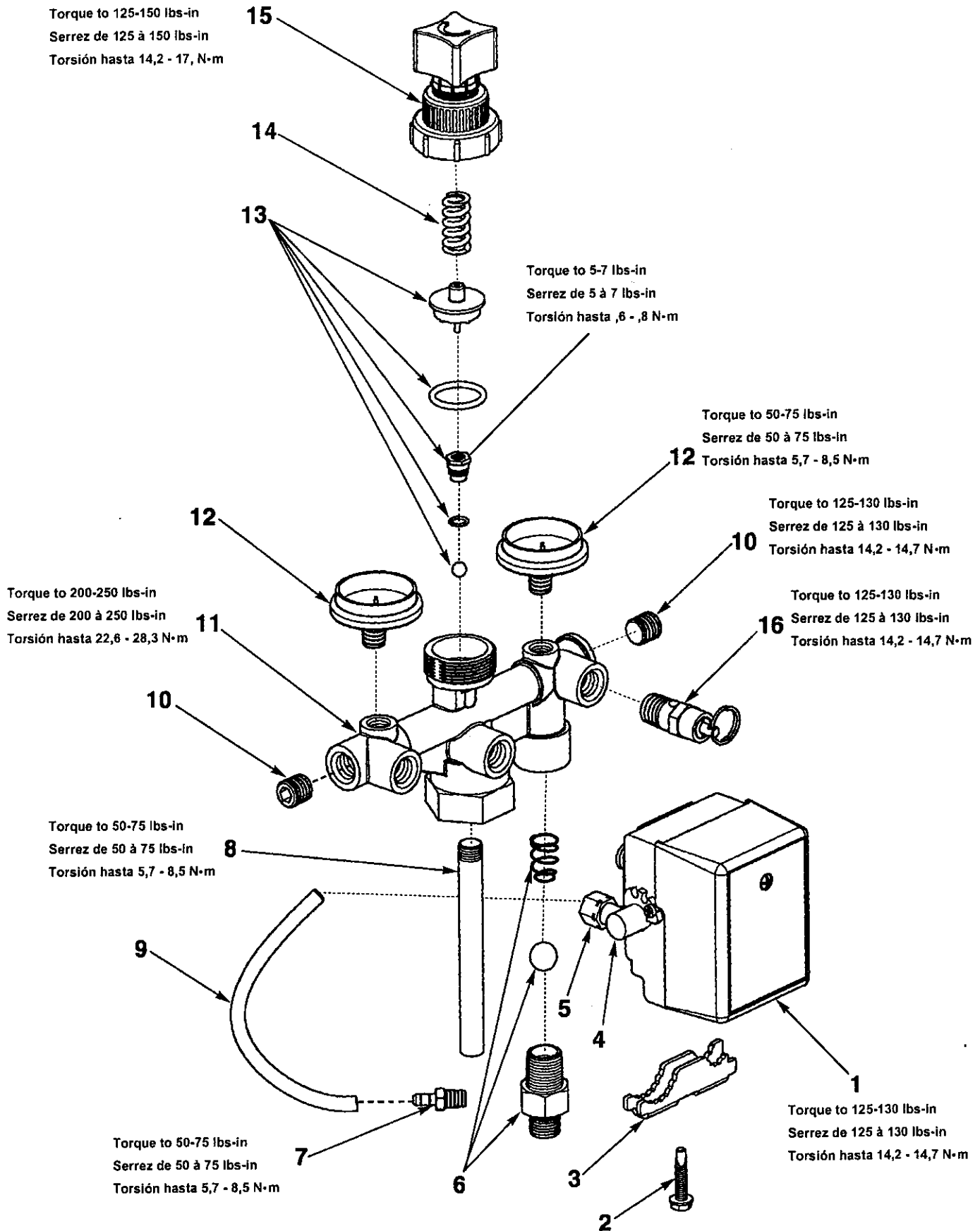

*N/A - Estas son piezas estándares disponibles en su ferretería local.



Note: Tighten compression nut #5 handtight plus 1 full turn.

Note: Serrez l'écrou #5 de compactage solide plus 1 plein tour.

Nota: Apriete la tuerca #5 de la compresión handtight más 1 vuelta completa.

Item Art Art	Part No Nº / P Núm / P	Qty Qté Cant	 Description	 Description	 Descripción
1	034-0135	1	Pressure switch <i>includes items 2 - 5</i>	Interrupteur <i>includ les élément 2 - 5</i>	Manómetro <i>incluye los articulo 2 -5</i>
2	061-0121	1	Screw	Vis	Tornillo
3	071-0013	1	Strain Relief	Soulagement de traction	Aliviador de esfuerzo
4	136-0064	1	Bleeder valve <i>includes item 3</i>	Soupape <i>includ les élément 3</i>	Válvula <i>incluye los articulo 3</i>
5	058-0017	1	Nut, 1/4" O.D. tube.....	Écrou	Tuerca
6	139-0013	1	Check valve assy	Clapet de retenue	Válvula de contraflujo
7	068-0061	1	Connector, 1/16 NPT x 1/4" ..	Connecteur	Conector
8	065-0089	1	Nipple, 1/8" x 4"	Manchon fileté	Niple
9	145-0324	1	Bleeder tube <i>Also purchase 058-0017 qty 1</i>	Tube..... <i>también être acheté</i>	Tubo <i>aussi debe comprar</i>
10	062-0035	2	Plug	Bouchon	Tapón
11	041-0045	1	Manifold.....	Collecteur.....	Múltiple
12	032-0056	2	Gauge	Manomètre.....	Manómetro
13	105-0004	1	Regulator repair kit	Jeu de pièces de réparation	Juego de reparación
14	055-0005	1	Spring	Ressort.....	Resorte
15	137-0001	1	Knob assy	Ensemble du bouton	Conjunto de perilla
16	136-0056	1	Valve, ASME	Soupape	Válvula

Pump specifications
Weight - 34 Lbs Approx.
Max Rpm - 3500



Spécifications de la pompe
Poids - 15,4 Kg
Régime maximum - 3500 Tr/Min

Especificaciones de la bomba
Peso - 15,4 Kg
Rpm Max - 3500

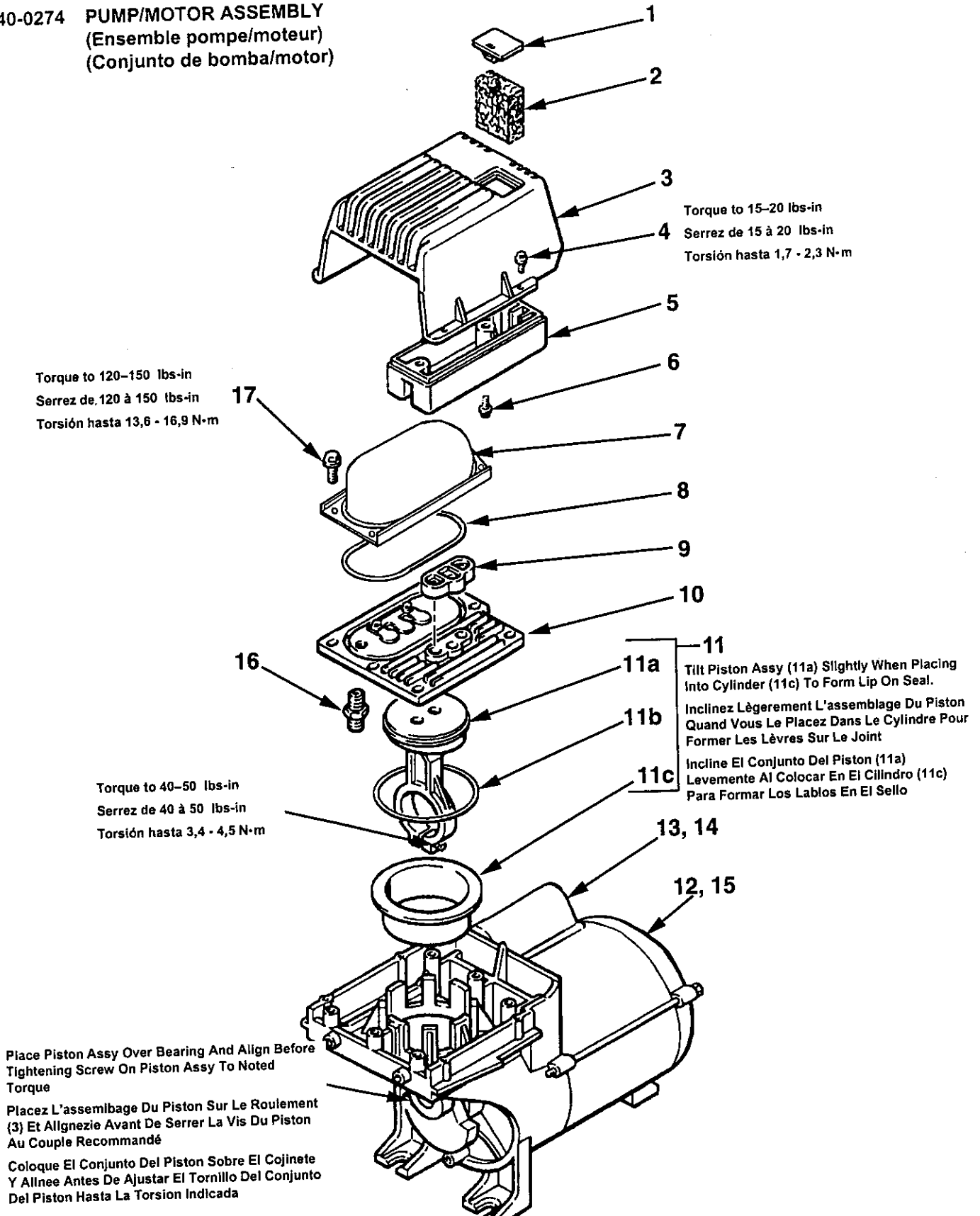
040-0274 PUMP/MOTOR ASSEMBLY
(Ensemble pompe/moteur)
(Conjunto de bomba/motor)



040-0274

Item Art Art	Part No N° / P Núm / P	Qty Qté Cant	 Description	 Description	 Descripción
1	077-0118	1	Cover	Couvercle	Tapa
2	019-0152	1	Filter	Filtre	Filtro
3	042-0089	1	Cover assy..... includes items 1, 2, 3, 5 & 6	Ensemble du couvercle inclut les éléments 1, 2, 3, 5 & 6	Conjunto de tapa incluye los artículos 1, 2, 3, 5 & 6
4	N/A	4	Screw, #8-32 x .38" lg	Vis	Tornillo
5	N/A	1	Manifold (order 042-0089)	Collecteur	Múltiple
6	N/A	2	Screw, #8-32 x .75" lg	Vis	Tornillo
7	117-0011	1	Manifold exhaust.....	Collecteur	Múltiple
8	054-0157	1	O-ring	Joint torique	Anillo tórico
9	046-0231	1	Seal.....	Joint	Sello
10	043-0151	1	Valve plate assembly	Ensemble de la plaque de soupape	Conjunto de placa de válvula
11	048-0074	1	Piston & cylinder assy..... <i>includes items 11a-11c</i>	Ensemble du piston et du cylindre <i>inclut les éléments 11a-11c</i>	Conjunto de cilindro y pistón <i>incluye los artículos 11a-11c</i>
11a	N/A	1	Piston assy	Ensemble du piston	Conjunto de pistón
11b	054-0158	1	O-ring.....	Joint torique	Anillo tórico
11c	N/A	1	Cylinder.....	Cylindre.....	Cilindro
12	040-0274	1	Motor assy	Ensemble du moteur.....	Conjunto de motor
			must be purchased as complete pump/motor assy	vendu en une seule ensemble pompe/moteur	se debe comprar como un conjunto completo de bomba/motor
13	166-0105	1	Capacitor, start, black	Condensateur	Condensador
14	166-0103	1	Cover	Couvercle.....	Tapa
15	077-0137	1	Cover, terminal	Couvercle.....	Tapa
16	068-0017	1	Connector	Connecteur	Conector
17	061-0062	6	Screw, 1/4 - 20 x 1.12" lg	Vis	Tornillo

Service kits available**Jeux de pièces d'entretien disponibles****Juegos de servicio disponibles**

046-0234	Seal kit	Jeu de joints.....	Juego de sellos
	includes items 8, 9, & 11b	inclut les éléments 8, 9 & 11b	incluye los artículos 8, 9 & 11b

*N/A - These are standard parts available at your local hardware store.

*N/A - Ces pièces sont des pièces standard disponibles en quincaillerie.

*N/A - Estas son piezas estándares disponibles en su ferretería local.